

MOMENTUM *GT*

advanced FLOW engineering Cold Air Intake System

Instruction Manual P/N: 50-70078D / 50-70078R

Make: Ford
Make: Ford

Model: Bronco Sport
Model: Escape

Year: 2021-2022
Year: 2020-2022

Engine: I3-1.5L (t)
Engine: I3-1.5L (t)



9

- Please read the entire instruction manual before proceeding.
- Ensure all components listed are present.
- For technical support please call 951-493-7185.
- Ensure you have all necessary tools before proceeding.
- Do not attempt to work on your vehicle when the engine is hot.
- Retain factory parts for future use.

Label	Qty.	Description	Part Number
A1	1	Air Filter (Pro 5R)	20-91202R
A2	1	Air Filter (Pro DRY S)	20-91202D
B	1	Tube, Driver	05-5070078B1
C	1	Housing	05-5070078B2
D	1	Screw, Flange Hex Head: M6 x 1.00 x 25mm	03-50774
E	1	Grommet, Rubber	03-50167
F	1	Fitting, Air Temp Sensor	05-01454
G	1	Clamp, 044 (2-5/16" - 3-1/4")	03-50019
H	1	Coupling, Silicone Bellow Rdr: (3"x2-5/8")ID X 3"L	05-01730
J	1	Clamp, 048 (2-9/16" - 3-1/2 ")	03-50007
K	1	Plug, Silicone: 2.25" Dia	05-01482

Installation will require the following tools:

Panel clip remover, 7mm & 8mm nut driver, 10mm deep socket and driver, 4mm and 10mm socket and driver

Warranty Information available at <https://afepower.com/contact#warranty>

Emissions Disclaimer: This product is not currently CARB exempt and is not available for purchase in California or for use on any vehicle registered with the California Department of Motor Vehicles.

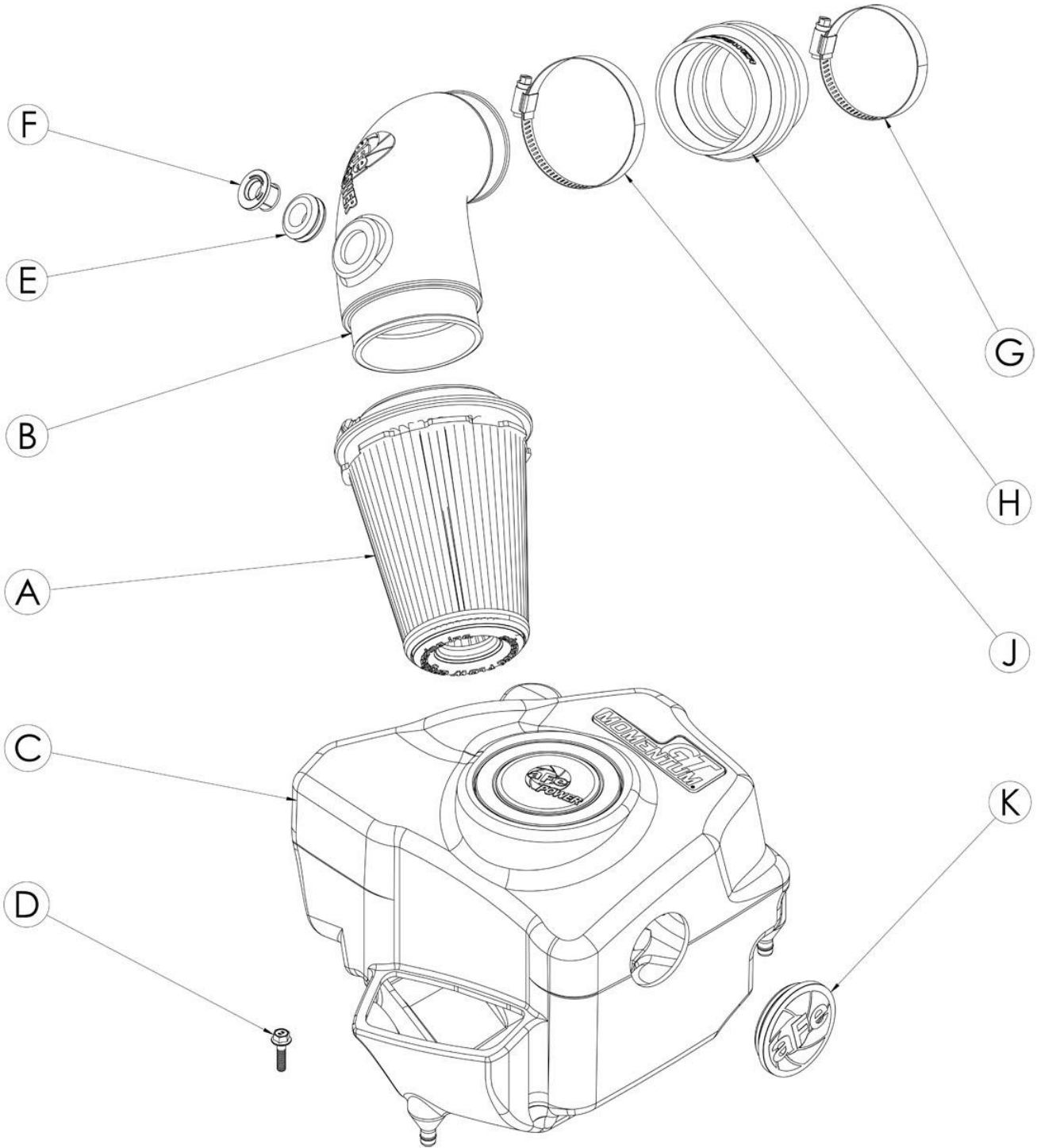



Figure A

Refer to Figure A for Step 1

Step 1: Using a panel clip remover, remove the two (x2) panel clips ① holding the scoop shield. Remove the scoop shield and set it aside with the clips.

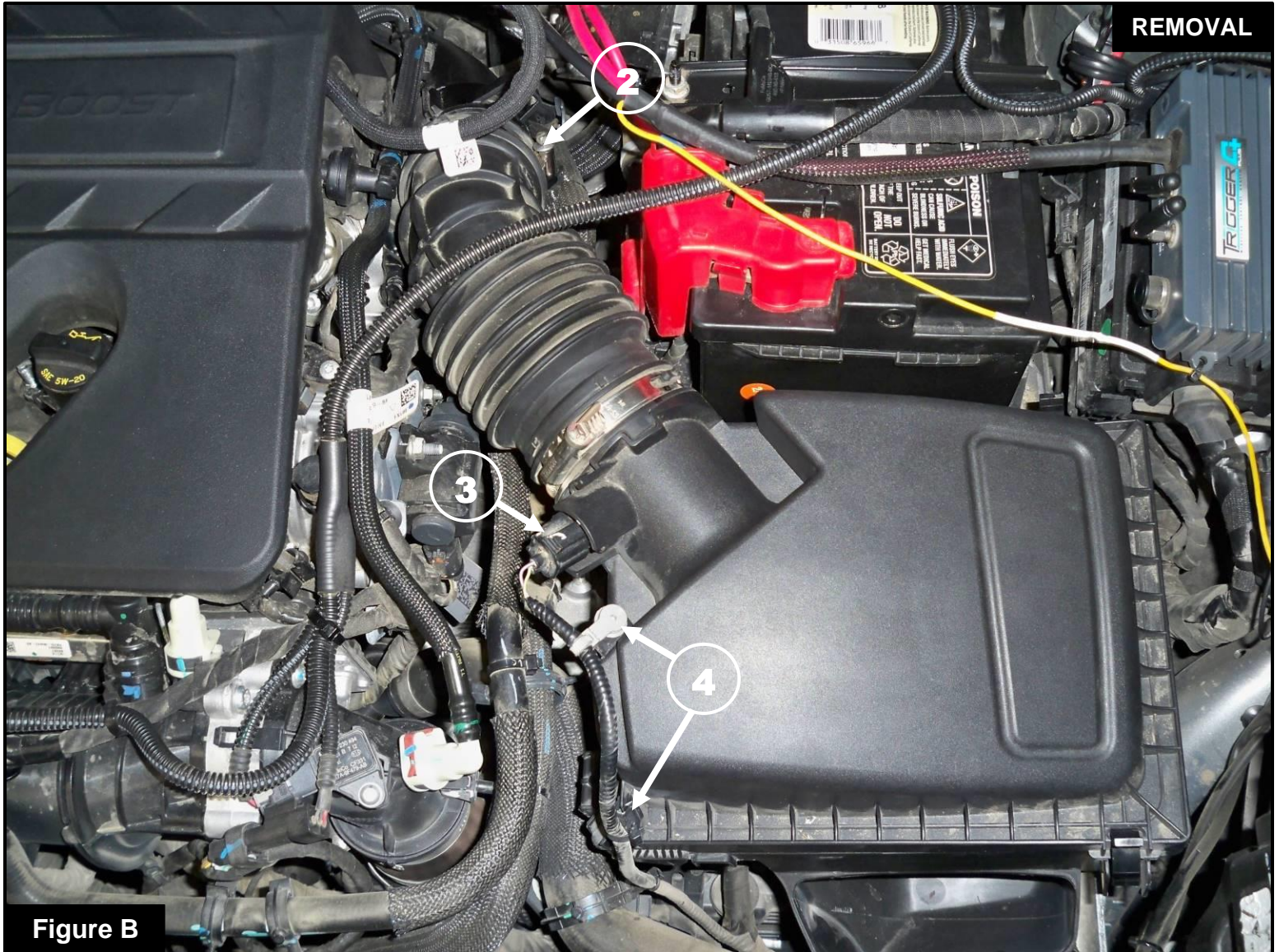

Figure B

Refer to Figure B for Steps 2-4

Step 2: Using a 7mm nut driver, loosen the clamp ② at the factory intake tube. Detach the factory rubber tube from the factory intake tube.

Step 3: Disconnect the IAT sensor electrical connector ③.

Step 4: Release the clips ④ and position the wiring harness aside.

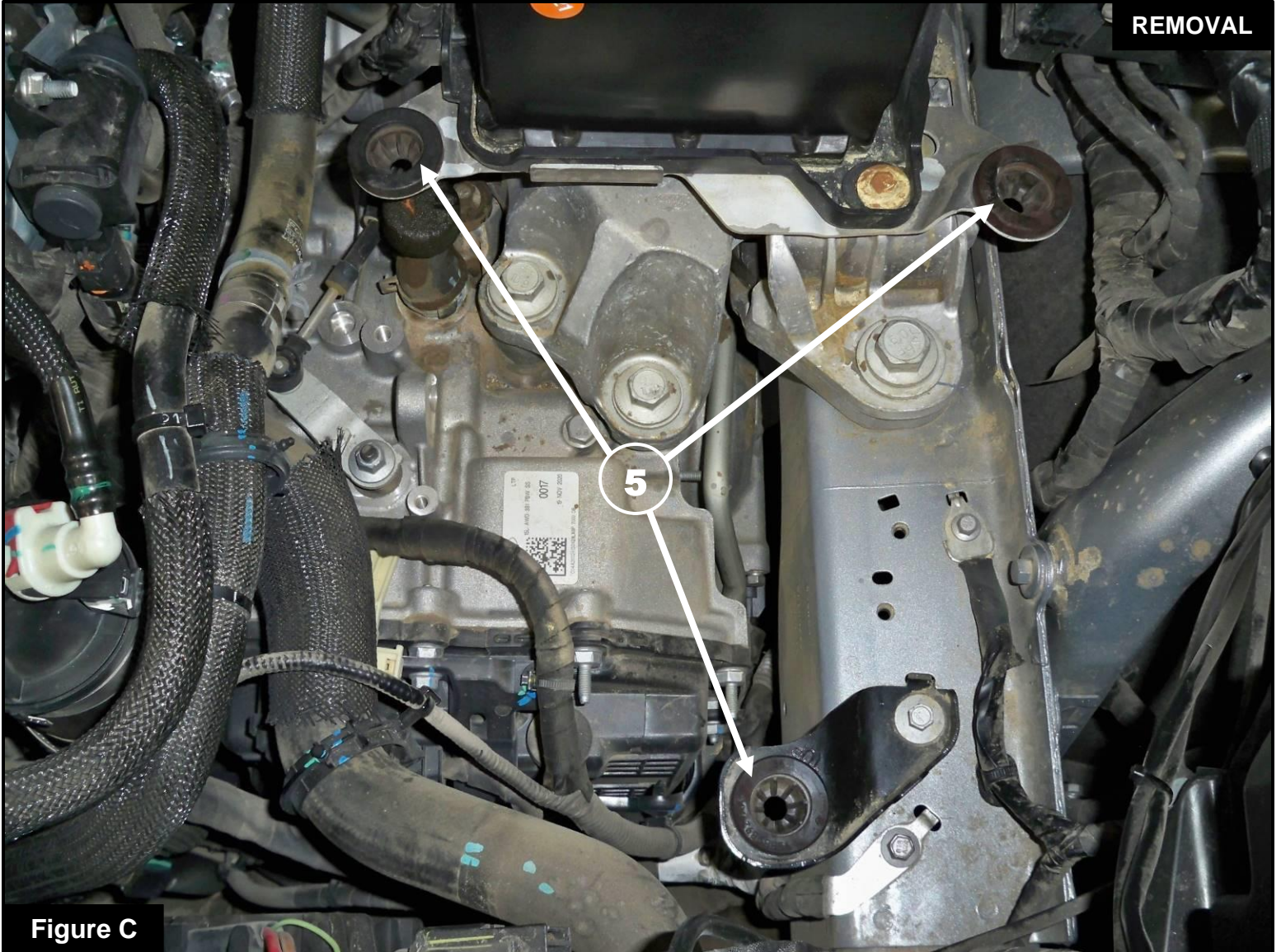
**Figure C****Refer to Figure C for Step 5**

Step 5: Detach and remove the factory airbox from the isolators (5). If the isolators are pulled out and are stuck in the lower half of the factory airbox, remove them and insert them back on the mounting bracket.

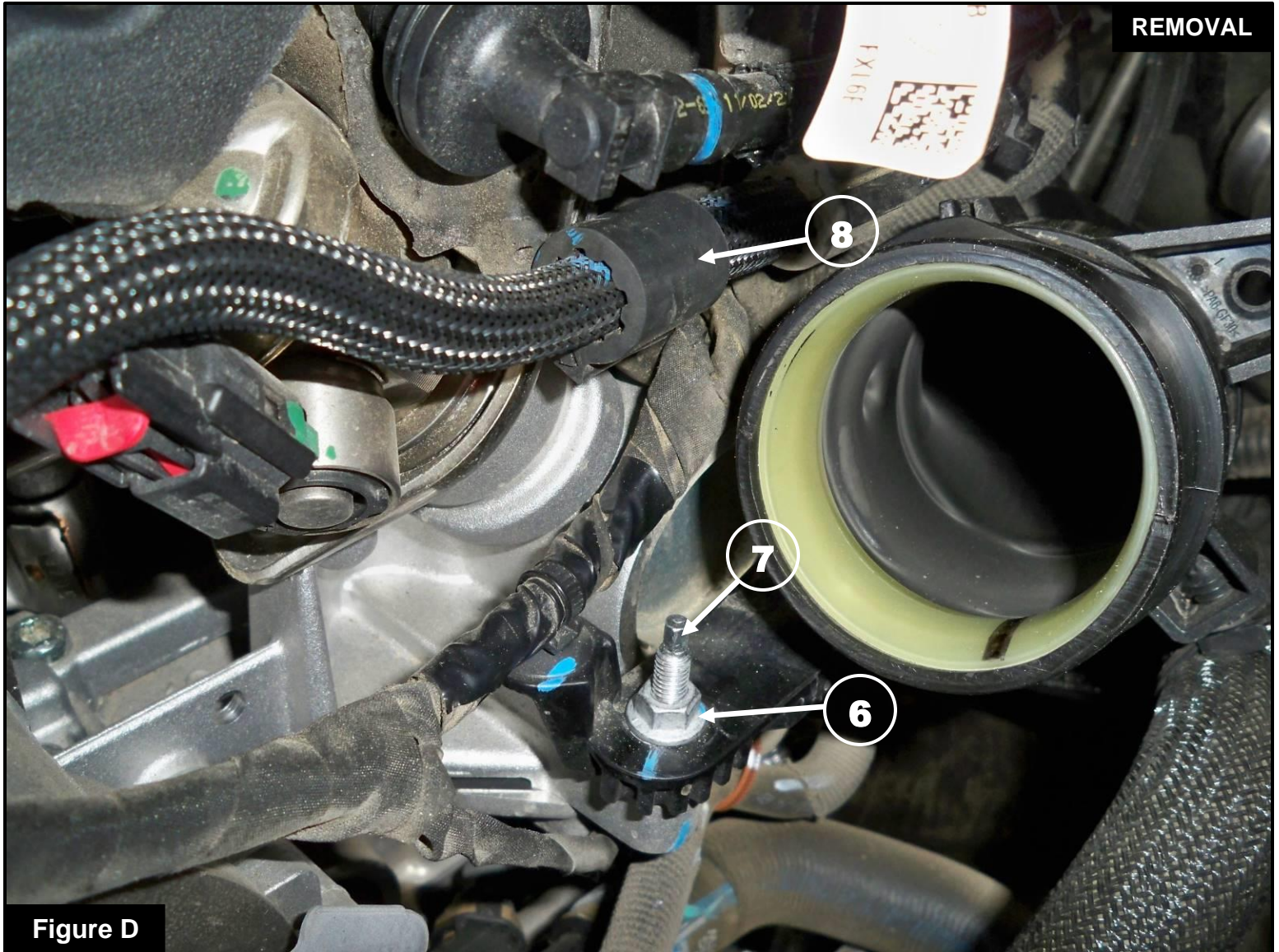

Figure D

Refer to Figure D for Step 6-8

Step 6: Using a 10mm deep socket and driver, remove the nut (6) holding the factory intake tube.

Step 7: Using a 4mm socket and driver, remove the stud (7) and replace it with the provided M6x25mm screw. Tighten the screw using a 10mm socket and driver.

Step 8: Remove the rubber isolator (8) from the hose.



Figure E

Refer to Figure E for Steps 9-11

Step 9: Install the aFe POWER housing into the vehicle. Make sure housing pins are aligned and all the way through the isolators.

Step 10: Install the air cleaner scoop shield and the two (x2) clips ⑨ while snapping into the aFe POWER housing.

Step 11: Install the supplied aFe plug ⑩ on the side of the aFe POWER housing as shown.

NOTE: This plug is accessible to be removed and installed at any time to increase airflow and engine sound if desired.



Refer to Figure F for Step 12

Step 12: Slide the aFe POWER filter and clamp into the aFe POWER housing and push them in until it locks into place. Do not tighten the clamp at this time.

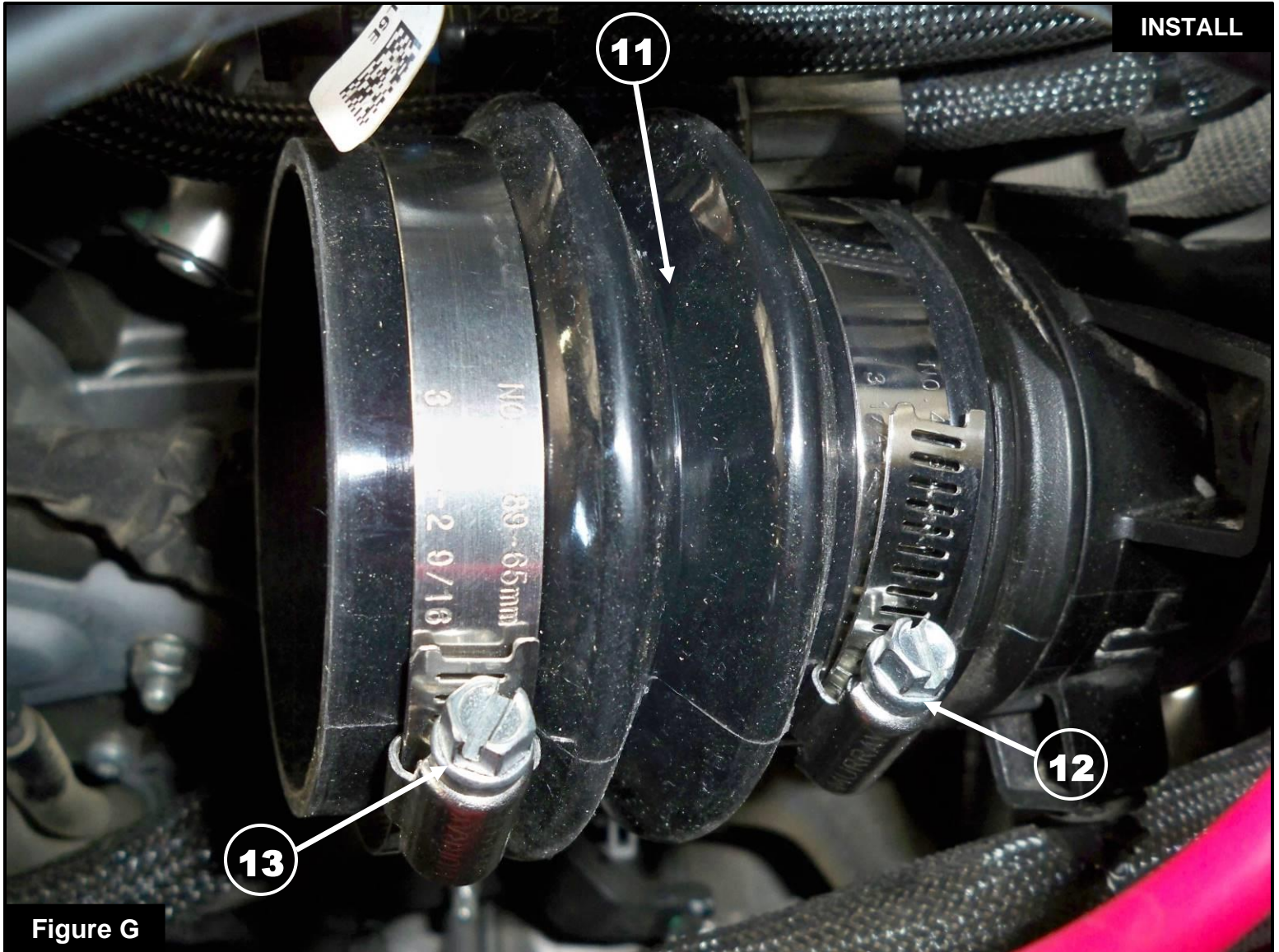
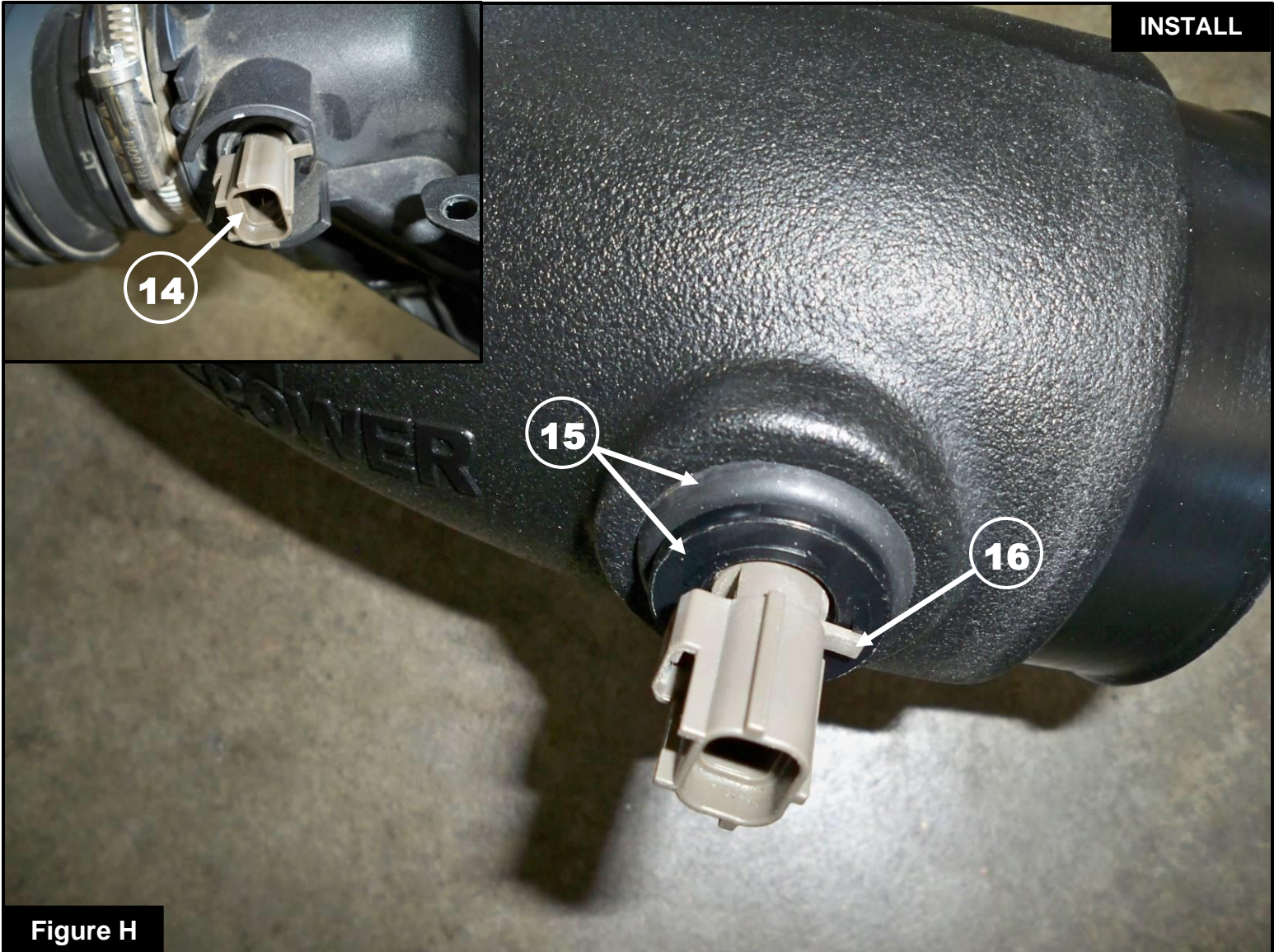

Figure G

Refer to Figure G for Steps 13-14

Step 13: Install the supplied coupling (11) with the small end onto the factory intake tube with the supplied #44 clamp (12) and tighten the clamp using an 8mm nut driver.

Step 14: Place the supplied #48 clamp (13) onto the coupling and slightly snug so it will not fall off.

**Figure H****Refer to Figure H for Steps 15-17**

Step 15: Remove the IAT sensor (14) from the factory airbox by rotating $\frac{1}{4}$ turn counterclockwise and gently pulling out.

Step 16: Install the provided grommet and temp sensor fitting (15) into the the filter side of the aFe POWER intake tube.

NOTE: Lubricant can be used to facilitate the installion of the fitting into the grommet.

Step 17: Install the IAT sensor into the temp sensor fitting by rotating $\frac{1}{4}$ turn clockwise until it locks into place. Rotate the temp sensor fitting to have mounting tab (16) pointing in the direction of the tube opening as shown.

**Figure I****Refer to Figure I for Steps 18-20**

Step 18: Install the aFe POWER intake tube into the coupling first and then into the air filter. Align the tube correctly and tighten the clamps using an 8mm nut driver.

Step 19: Connect the IAT sensor electrical connector (17).

Step 20: Check all the components are tight and secure. Your installation is now complete. Thank you for choosing aFe POWER!

NOTE: Check all bolts, clamps, and connectors after 100-200 miles.



Page left blank intentionally



Page left blank intentionally



Page left blank intentionally

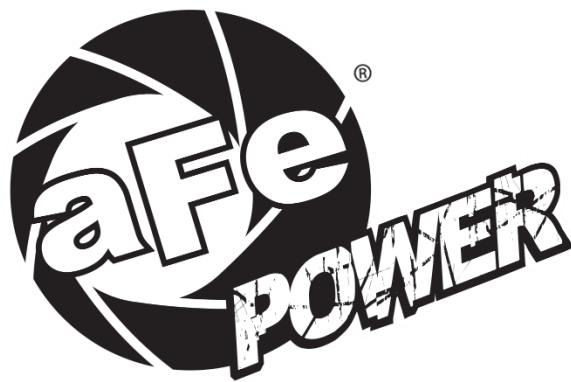

advanced FLOW engineering, inc.

252 Granite Street Corona, CA 92879

<https://afepower.com/contact>